

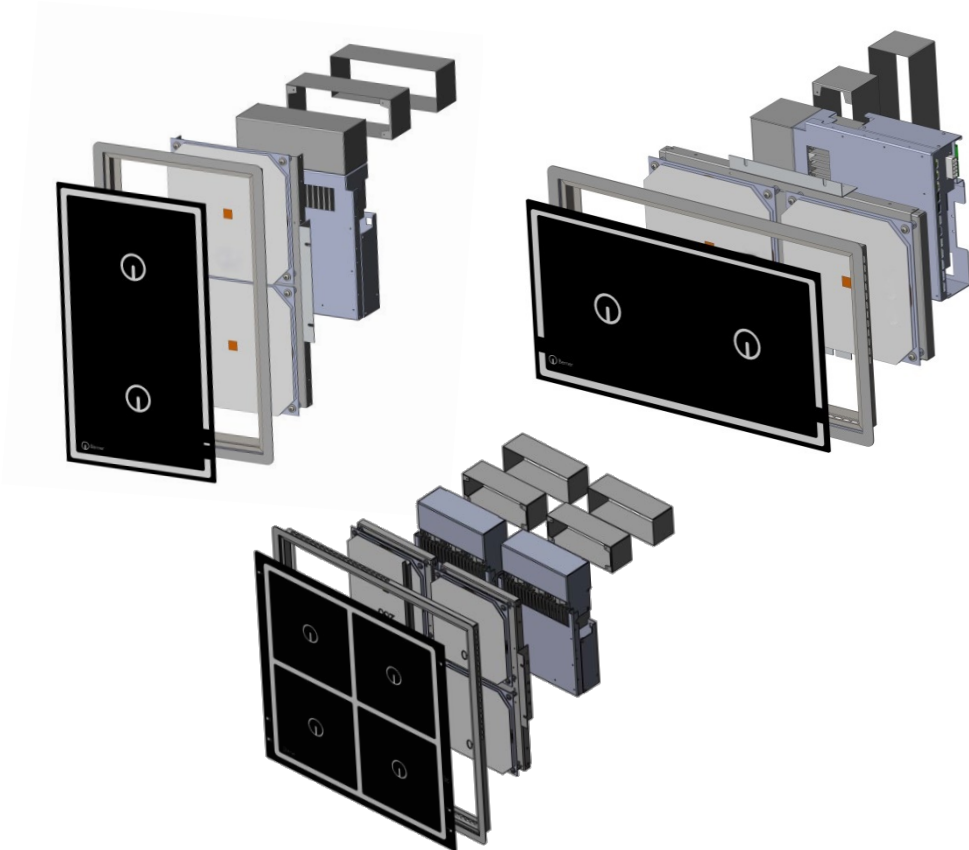

Berner- Kochsysteme GmbH & Co. KG

Sudetenstrasse 5 - D-87471 Durach
Tel. +49 (0) 831/697247-0; Fax. - 15
Email: Berner@induktion.de | www.induktion.de

Original User manual
Installation-induction devices



Be **sure to read** the instructions for use and assembly
before installation - installation - commissioning.
This protects you and prevents damage.

Table

Table	1
Safety.....	4
Safety regulations	5
Description of Hazard Symbols	5
Dangers in case of non-observance of safety regulations	5
Safe use.....	5
Improper operation.....	6
Changes / use of spare parts	6
Pan detection	7
Monitoring of the heating zone	7
Noise	7
General.....	7
Application.....	7
Product	7
Products.....	7
Technical data	7
Operation and control.....	7
Technical device data	8
Power table 1 channel (single generator BIPS, BIPMS)	8
Applications	8
Power table 2 channel (double generator GDP(D)MMS, BIPDMS, BIPDS)	9
Installation	11
Electrical data of the devices.....	11
Devices by power (3.5 kW- BIPMS3.5)	11
Devices by power (5 kW- BIPMS5)	11
Devices by power (5 kW, 7kW, 8kW, 9kW- BIPS).....	11
Devices by power (10 kW double generator BIPDS).....	11
Devices by power (3.5 kW- double generator BIPDMS3.5)	11
Devices by power (3.2 kW- double generator BIP(D)MMS3.5)	11
Functional conditions.....	12
Installationpresetzungen	12
Installation regulations for the installation model.....	12
Commissioning	13
Assembly.....	13
Devices on and off switch	14
Power control with potentiometer	14
Power control with touch	14
Power control with Spin Control.....	14
Warming function (optional)	15
How do I use the warm-up function	15
Pyro-Sensor ITC	15
Warming function with potentiometer.....	16
Warming function with pyro-sensor ITC and electronic potentiometer.....	16

Warming function with pyro sensor and touch	17
Warm holder.....	18
Warm holder with potentiometer	18
Warm holder with touch	18
Hot holder with Spin Control	19
Wipe Control.....	20
.....	20
Operation	20
Temperature	21
Residual heat indicator	21
Timer	21
Display in case of error.....	22
Dual operation (1 controller for both channels).....	22
Powerstar function double generator (devices with 400V double generator BIPDS)	22
Powerstar function (BI2EG3.5xx; BI4EG7xx)	23
Functional	23
Operation.....	24
Cooking process	24
Comfort.....	24
Pot detection.....	25
External display	25
Startup	25
Normal operation.....	25
Pot rating	25
Pot rating light with 1 display.....	25
Function with priority circuit (Dual Potentiometer control (optional))	26
Master Potentiometer (optional)	27
Decommissioning	28
Error detection.....	28
Potentiometer Error Handling	29
Troubleshooting	29
Overview Alerts on Display	31
Overview Faults on display	31
Cleaning.....	31
Guarantee	32
Repair during the warranty period	32
Maintenance	33
Disposal	33
Technical documents	33
Generatorviews.....	34
Spare parts	35
BIPS-Generator	35
BIPS Generators.....	36
Devices with BIPS generators:	36

BIPMS-GeneratorEn	37
BIPMS Generators	38
Devices with BIPMS generators:	38
BIPDS Generator	40
BIPDSGenerators.....	41
Devices with BIPDS generators:	41
BIPDMS/BIPDMMSGenerator	43
BIPDMSGenerators	44
Devices with BIPDMS generators:	44
GDP(D)MMS-Generators.....	45
Devices with BIPMMS/BIPDMMS generators:	45
Technical documentation	46
Gluing scheme for flush-mounted installation	46
Air flow	46
Observe installation regulations	48
Installationsvorschriften	48
Additional installation requirements for the installation model	48
Attention points for remote coil (coil - generator separated)	49
Installation instructions for the installation of.....	50
Induction devices with support frame (Ver. A).....	50
Installation instructions for flush-mounted installation	52
(Ver. B) of induction devices	52
Installation instructions for the installation of.....	54
Sensor keypads with support frame (Ver. A)	54
Installation instructions for flush-mounted installation	55
(Ver. A2) of sensor keypads.....	55
Installation instructions for flush-mounted installation	56
(Ver. B) of sensor keypads	56

Safety



Read this guide carefully. Keep the instructions for use and assembly for later use or for subsequent owners. Check the device after unpacking. Do not connect in the event of transport damage. Record the damage in writing and call the customer service, otherwise the warranty claim will not be waived. The installation of the device must be carried out in accordance with the attached installation instructions.

Use the device only for preparing food. Supervise the device during operation. Use the device only indoors. Do not use hob covers. They can lead to accidents, e.B. due to overheating, inflammation or cracking materials. Do not use unsuitable protective devices or child protection screens. They can lead to accidents. This device is not intended for operation with an external timer or remote control.

If you are wearing a pacemaker or other electronic body help, be careful when you are in front of a switched-on induction hob. Check with your doctor or medical device manufacturer for compliance or possible intolerance.

Fire!

- Hot oil and fat ignite quickly. Never leave hot oil and grease unattended. Never extinguish a fire with water. Switch off the cooking place. Carefully suffocate flames with lid, extinguishing blanket or similar.
- The cooking places get very hot. Never place combustible objects on the hob. Do not store any items on the hob.
- The device gets hot. Store non-flammable objects or spray cans in drawers directly under the hob.

Risk of combustion !

- The cooking stoves and their surroundings, in particular a possibly existing hob frame, become hot. Never touch the hot surfaces. Keep children away.
- The cooker heats, but the display does not work. Switch off the fuse in the fuse box. Call customer service.
- Metal objects get hot very quickly on the hob. Never place metal objects, such as .B knives, forks, spoons and lids on the hob.
- After each use, turn off the hob with the main switch. Do not wait for the hob to turn off automatically because there are no more pots and pans on it.

Risk of electric shock !

- Improper repairs are dangerous. Only customer service technician trained by us is allowed to carryout repairs and replace damaged connecting lines. If the device is defective, turn off the device or turn off fuse in the fuse box. Call customer service.
- Invading moisture can cause an electric shock. Do not use a high-pressure cleaner or steam cleaner.
- A defective device can cause an electric shock. Never turn on a defective device. Turn off the device or turn off the fuse in the fuse box. Call customer service.
- Jumps or fractures in the glass ceramic can cause electric shocks. Switch off the fuse in the fuse box. Call customer service.

Damage!

- The hob is equipped with a blower at the bottom. Observe the installation instructions for the air duct.

Attention!

- Rough pot and pan bottoms scratch the hob.
- Never place empty cooking vessels on the hob. This could lead to damage.
- Do not place hot pots or pans on the control panel, displays or hobs. This could lead to damage.
- If hard and pointed objects fall on the hob, damage can occur.
- Aluminum foil and plastic vessels melt on hot stoves. The use of stove protection film on the hob is not recommended.

Safety regulations

Description of Hazard Symbols

General danger symbol

Failure to comply with safety regulations means danger (injuries)



This symbol warns of **dangerous tension**.
(Figure 5036 of IEC 60417-1)



This symbol warns against **non-ionizing electromagnetic radiation**.
(Figure 5037 of IEC 60417-1)

Attention

In case of improper use
may cause minor injuries or
damage to property!

Danger symbols directly attached to the device must be followed and readability must be ensured at all times.

Attention

The user manual must be read before using or
maintaining the device.

Dangers in case of non-observance of safety regulations

Failure to comply with the safety regulations can lead to danger to persons, the environment and to the induction system itself. In the event of non-compliance with the safety regulations, there is no right to claim any damages.

In detail, failure to observe the following risks may result in the following risks

(Examples):

- Danger to persons due to electrical causes
- Danger to people from overheated pans
- Danger to persons due to overheated storage area (ceramic field)

Safe use

The safety provisions of this manual, the existing national rules on electricity to prevent accidents and any internal working, application and safety regulations must be followed.

- **Attention!** Cookware may only be placed on the stove with a full extent. Do not place hot pots or pans on the control panel, displays or hobs. Ignoring this notice will damage the pots and equipment. **Effect in ignoring:** Pots are welded together, burning the joint material by heat of the pots and thus destroying the seal, leading to penetration of moisture and grease and can thus lead to the defect of the device. Defect of the displays or control panels.
- If the ceramic glass is torn or broken, the inductionerät must be switched off and disconnected from the electrical supply. Do not touch any parts inside the induction.
- The ceramic field is warmed by the heat of the pan. To avoid injuries (burns), do not touch the ceramic field.
- Please be wareify against hot food and liquids.
- **PLEASE NOTE:** Warning of possibly slippery ground in the vicinity of the device. This can lead to injuries.

- To avoid overheating of the pans by empty cooking, do not heat the pan unattended and without cooking.
- Turn off the heating zone if you take the pan away for a while. This prevents the heating process from automatically start when a pan is placed back on the heating zone. Thus, unattended heating is avoided, i.e. a person who wants to use the inductiongerät must start the heating process by switching on the device or by turning the power controller to 'ON'.
- Do not use the cooking surface as a shelf!
- Do not place paper, cardboard, fabric etc. between the pan and ceramic field as it could ignite. Aluminium foils and plastic vessels must not be placed on the hot surfaces.
- Care must be taken to ensure that during the operation of the device, items worn by the user, such as B rings, watches, etc., can become hot when they come close to the cooking level.
- After use, the hot plate must be switched off by means of its control and/or control device. Do not rely on pot detection.
- Do not place credit cards, phone cards, cassettes or other magnetic-sensitive items on the ceramic field.
- Only recommended types and sizes of vessels may be used.
- The inductiongerät has an internal air cooling system. Avoid obstructing the air supply and air outlet zone with objects (e.B. fabric). This would cause overheating and therefore the device's shutdown.
- Avoid the entry of liquids into the device and overflow water or cooking material over the edge of the pan. Do not clean the device with a water jet.

Improper operation

The functionality of the inductiongerätit can only be guaranteed if used correctly. The limit values in accordance with the technical data may not be exceeded or exceeded under any circumstances.

Changes / use of spare parts

Contact the manufacturer if you intend to make changes to the device. To ensure safety, use only original spare parts and accessories approved by the manufacturer. When using non-original components, all liability for follow-up costs expires. **When disassembly, testing or repairs, pay attention to the stability of the device.**

Attention! When replacing spare parts, the induction device must be "visibly tt" from the power supply.

Pan detection

Pans with a diameter of less than 12 cm (bottom) are not recognized. During operation, the power indicator lamp, LED or digital display indicates the selected power level (1-9). When operating without a pan or an unsuitable pan material, no power is emitted, the power indicator lamp flashes only briefly or the indicator does not report a pot detected [see error messages](#).

Monitoring of the heating zone

The heating zone is monitored by a temperature sensor (middle of the cooker) located under the ceramic field. Overheated pans (hot oil, empty pans) can be detected in the middle of the cooking place. The energy supply is stopped. The device only transfers energy back to the pan until the temperature has dropped to a normal level.

Attention! Only the cooking appliance is protected from overheating, not the pan. The overheated pan is not detected until the overheating of the ceramic field has reached the shutdown temperature (260°C).

Noise

The fans of the cooling are audible, but switch off again in between.

General

This manual contains basic information that must be observed during assembly, application and maintenance. It must be read completely by the installer and the operator before installation and commissioning, and must always be located near the cooking station for a look-up.

Application

The inductiongeräte are used for preparing meals. They can be used for cooking, keeping warm, flaming, grilling, etc. of food. Attention, only induction-grade pan material must be used on induction gerät en. For the use of the pan material, only products recommended by us and suitable for professional use should be used. The entire bottom of the pan must be magnetic. In case of doubt, this can be tested with the help of a permanent magnet.

Product

Products

- Compact modular design
- Easy operation by rotary knob
- Compact power electronics enable easy and safe operation
- Max operational safety thanks to various protection and monitoring functions
- Continuous power control with electronic overtemperature protection of the performance part.
- **At 300x300F and Sauteusensspulen:5-Fühler-Temperaturüberwachung für verbesserten Topfschutz.**

Technical data

Operation and control

Lamp " Operation or pot detection "	2V DC/approx. 10mA (LED green)
Power Controller - Potentiometer 00hm - 10kOhm	
Digital display " Power and error display "	2.8V DC/approx. 60mA (red)
Lamp " Operation " green (devices with main switch)	

Technical device data

Power table 1 channel (single generator BIPS, BIPMS)

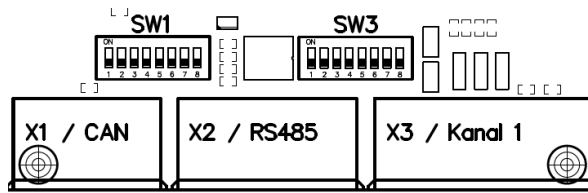

Block	Mwp	Function	Off	On
Switch 1	4	Performance setting	See performance table	
	5			
Switch 1	8	Master Potentiometer Function Generator 2 takes potentiometer value from generator 1	From	A
	1	Control procedure Pulse for installation and multi-cooker units Frequency for single cookers	Impulse	Frequency
Switch 3	2	CAN ID / Operating Frequency CAN address when two devices are connected Frequency shift at low coil distances (pulse mode only)	ID 1 (f=0Hz)	ID 2 (f=-70Hz)
	3	Pan detection Sensitivity	00 default	
	4		01 -10%	
	5	Application settings	10 +10%	
	6		11 +20%	
	7		See application table	
8				

Applications

Sw3 5678	No.	230V 1ph	230V 3ph	400V 2ph	400V 3ph
0000	1	R 18cm	R 22cm	R 22cm	R 27cm
0001	2	R 22cm	R 25cm	R 25cm	R 30cm
0010	3	Q 20cm			Q 27cm
0011	4	Q 23cm			Q 30cm
0100	5		W 22cm	W 22cm	D 26cm
0101	6		W 25cm	W 25cm	D 30cm
0110	7				G 185u
0111	8				G 180u
1000	9				R 35cm
1001	10 (A)				
1010	11 (B)	Warm holder 60°-90°C			
1011	12 (C)	Warm holder 60°-150°C			
1100	13 (D)	S 18cm			
1101	14 (E)				
1110	15 (F)				
1111	16 (G)	Grill controller 70°-250°			

Power table 1 phases generator / 2 phase generator BIPMS

Sw1 4 5	Type 230V Current [A]	Power[kW]	Type 400V Current [A]	Power[kW]
0 0	8	1.8	7.5	3.0
0 1	10.9	2.5	8.75	3.5
1 0	13.1	3.0	10.0	4.0
1 1	15.3	3.5	12.5	5.0

Power Table 3 Phases Generator BIPS

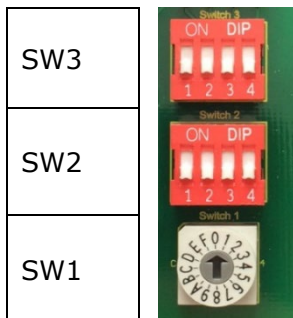

Sw1 4 5	Type 400V Current [A]	Power[kW]	Type 230V Current [A]	Power[kW]
0 0	5.1	3.5	7.5	3.0
0 1	7.25	5.0	8.75	3.5
1 0	10.2	7.0	10.0	4.0
1 1	12.3	8.5	12.5	5.0

Power table 2 channel (double generator GDP(D)MMS, BIPDMS, BIPDS)





Block	Sw.	Function	Off	On
Switch 3	1	Pot detection Sensitivity setting of pot detection	Normal	Fine +10%
Switch 2	1	Mode Deactivate Channel 2	2 Channel operation	1 channel operation
	3	Performance Application-dependent performance setting	Level I (Low)	Level II (High)
Switch 1		Application settings See Applications and Services	Rotary switch 0-F	











Power table 1 phases doublegenerator GDP(D)MMS 1x230V Mach3

SW1	Application		Power Channel 1 [kW]				Power Channel 2 [kW]			
			Single operation		Dual operation		Single operation		Dual operation	
			Low	High	Low	High	Low	High	Low	High
1		KR210 60-H	2.5	3.2	1.2	1.6	2.5	2.5	1.2	1.6
3		R220 60H	2.5	3.2	1.2	1.6	2.5	3.0	1.2	1.6
6	Wok	W30 75H	2.5	3.2	1.2	1.6	2.5	2.5	1.2	1.6
A	Wh	WH60-90	0.9	1.5	0.9	1.5	0.9	1.5	0.9	1.5
B	Wh	WH60-150	0.9	1.5	0.9	1.5	0.9	1.5	0.9	1.5

Performance table 1 phases doublegenerator BIPDMS 1x230V Mach4

SW1	Application		Power Channel 1 [kW]				Power Channel 2 [kW]			
			Single operation		Dual operation		Single operation		Dual operation	
			Low	High	Low	High	Low	High	Low	High
1		R220 60H	2.5	3.5	1.2	1.8	2.5	3.0	1.2	1.8
3		Q270 65H	2.5	3.5	1.2	1.8	2.5	3.0	1.2	1.8
6	Wok	W30 65H	2.5	3.5	1.2	1.8	2.5	3.0	1.2	1.8
A	Wh	WH60-90	0.9	1.5	0.9	1.5	0.9	1.5	0.9	1.5
B	Wh	WH60-150	0.9	1.5	0.9	1.5	0.9	1.5	0.9	1.5
C	Grill	GR70-250 205H	2.5	3.0	1.2	1.8	2.5	3.0	1.2	1.8

Power table 3 phases double generator BIPDS 3x400V

SW1	Application		Power Channel 1 [kW]				Power Channel 2 [kW]			
			Single operation		Dual operation		Single operation		Dual operation	
			Low	High	Low	High	Low	High	Low	High
0		R230 230H	3.5	5.0	3.5	5.0	3.5	5.0	3.5	5.0
1		R260 230H	3.5	5.0	3.5	5.0	3.5	5.0	3.5	5.0
2		R280 230-H	5.0	7.0	5.0	5.0	5.0	5.0	5.0	5.0
3		Q250 235H	3.5	5.0	3.5	5.0	3.5	5.0	3.5	5.0
4		Q270 230H	3.5	5.0	3.5	5.0	3.5	5.0	3.5	5.0
5		D280 215-H	3.5	5.0	3.5	5.0	3.5	5.0	3.5	5.0
6		D300 215-H	3.5	5.0	3.5	5.0	3.5	5.0	3.5	5.0
7		2G320 220-H	3.5	5.0	3.5	5.0	3.5	5.0	3.5	5.0
8		2G360 220-H	3.5	5.0	3.5	5.0	3.5	5.0	3.5	5.0
A	Wok	W30 230H	3.5	5.0	3.5	5.0	3.5	5.0	3.5	5.0
B		S260 230H	3.5	5.0	3.5	5.0	3.5	5.0	3.5	5.0

C		GR70-250 205H	3.5	5.0	3.5	5.0	3.5	5.0	3.5	5.0
---	--	------------------	-----	-----	-----	-----	-----	-----	-----	-----

Installation

Electrical data of the devices

Devices by power (3.5 kW- **BIPMS3.5**)

Induction cooktop 1-phase (voltage 230Volt +5% / -10%)

<u>Connection</u>	<u>Color</u>	<u>Frequency</u>	<u>Backup</u>
Phase	Brown, Black or 1	50 Hz / 60 Hz	1 x 20A F (fast)
N	Blau or 2	Working frequency 22-35 kHz	Tax security -
Pe	Yellow/Green		

Devices by power (5 kW- **BIPMS5**)

Induction cooktop 2-phase (voltage 400Volt +5% / -10%)

<u>Connection</u>	<u>Color</u>	<u>Frequency</u>	<u>Backup</u>
Phase	Brown, Black or 1.2	50 Hz / 60 Hz	1 x 16A F (fast)
N	Blau or 4	Working frequency 22-35 kHz	Tax security -
Pe	Yellow/Green		

Devices by power (5 kW, 7kW, 8kW, 9kW- **BIPS**)

Induction cooktop 3-phase (voltage 400Volt +5% / -10%)

<u>Connection</u>	<u>Color</u>	<u>Frequency</u>	<u>Backup</u>
Phase	Brown, Black, Grey or 1, 2, 3	50 Hz / 60 Hz	3 x 16A F (fast)
N	Blau or 4	Working frequency 22-35 kHz	Tax security -
Pe	Yellow/Green		

Devices by power (10 kW double generator **BIPDS**)

Induction cooktop 3-phase (voltage 400Volt +5% / -10%)

<u>Connection</u>	<u>Color</u>	<u>Frequency</u>	<u>Backup</u>
Phase	Brown, Black, Grey or 1, 2, 3	50 Hz / 60 Hz	3 x 16A F (fast)
N	Blau or 4	Working frequency 22-35 kHz	Tax security -
Pe	Yellow/Green		

Devices by power (3.5 kW- double generator **BIPDMS3.5**)

Induction cooktop 1-phase (voltage 230Volt +5% / -10%)

<u>Connection</u>	<u>Color</u>	<u>Frequency</u>	<u>Backup</u>
Phase	Brown, Black or 1	50 Hz / 60 Hz	1 x 20A F (fast)
N	Blau or 2	Working frequency 22-35 kHz	Tax security -
Pe	Yellow/Green		

Devices by power (3.2 kW- double generator **BIP(D)MMS3.5**)

Induction cooktop 1-phase (voltage 230Volt +5% / -10%)

<u>Connection</u>	<u>Color</u>	<u>Frequency</u>	<u>Backup</u>
Phase	Brown, Black or 1	50 Hz / 60 Hz	1 x 16A F (fast)
N	Blau or 2	Working frequency 22-35 kHz	Tax security -

		frequency 22-35 kHz	-
Pe	Yellow/Green		

Functional conditions

- max. tolerance of mains voltage nominal voltage+5%/-10%
- Frequency 50 / 60 Hz
- Protection class in delivery state IP 11
- min. pan diameter 12 cm

Installation environment

- **Maximum ambient temperature**

Storage > -20°C to +70°C in Function > +5°C to +35°C

- **maximum relative humidity**

Storage > 10% to 90% in function > 30% to 90%

Installationpresetzungen

The inductiongerät must be mounted in a straight surface by means of a mounting frame. The air supply and outlet area must not be obscured. The installation area must allow a weight of at least 100 kg. The mains disconnecter must be easily accessible.

Installation regulations for the installation model

The following points must be observed:

- Check and make sure that the voltage of the main supply line matches that of the type plate.

- The induction device must be connected to a PA line (6 mm² green/yellow-to 20kW, 16mm² green/yellow-over 20kW) to the connection screw (M6x10- up to 20kW, M8x10- over 20kW) and the building-side potential equalization point of the stove system.



- The induction device in separate design (generator coil separated) must be connected to a potential equalizing line (6 mm² green/yellow-to 20kW, 16mm² green/yellow-over 20kW) to the connection screw (M6x10-to 20kW, M8x10-over 20kW) and the potential equalization point of the generator compartment of the stove. If the generator compartment is outside the stove system, this must also be connected to the potential equalization point of the stove system on site.



The PE line (6mm² green/yellow) must be connected to the PE of the electrical supply line. The PE line has the same length as the coil extension.

- The electrical installations must comply with local building installation regulations. The applicable national regulations of the electricity authorities must be complied with.
- The inductiongerät is equipped with a power cable.
- If incorrect current circuit breakers are used, they must be designed for a fault current of at least $I_n = 30\text{mA}$.
- It is necessary to ensure that the appropriate RCD (Type B) fault current circuit breakers are installed for the electronic equipment.
- Prevent blocking of the air supply and air outlet zone by objects (fabric, wall, etc.)
- Avoid that hot ambient air is sucked in by the inductiongerät (several devices stand side by side, devices stand one after the other, near frying tippers or ovens). Otherwise, a duct must be used.

- The device has a suction filter. Nevertheless, you must ensure that no fat ambient air caused by other applications can be sucked into the inductiongerät (near fryers, grill plates or fryers).
- The air intake temperature must be below +35°C.
- Operators must ensure that all installation, maintenance and inspection work is carried out by approved personnel.
- The intake air must be channelled and fed directly to the fans via the supplied filter. The intake cross-section should be at least 200 cm² per electronic unit.
- Do not build a thermal short circuit. The exhaust air must not be sucked back in, otherwise the device will become hotter and hotter.
- The installation must be checked for practicality. For this purpose, the maximum cooling plate temperature must be determined. Measurements are made on the cooling plate base plate below the induction coil. The temperature must not exceed 65°C in continuous operation of at least 2 hours and 20°C ambient temperature.
- All INSTALLATION models must be fastened by means of an enclosed mounting frame.
- The power supply cable must be shielded in general and contacted cleanly on both sides.
- Provide the mains disconnecter in such a way that a maximum of 5 times per day is switched on and off.
- To maintain and replace parts, the device must be disconnected from the power supply. If a disconnect from the voltage of the device is provided, whereby it must be clearly pointed out that the separation must be done in such a way that the operator can control from any place to which he has access that the separation still exists. If this is not possible due to the design of the device or the installation, the separation must be ensured with a locking in the separation position.

The inductiondevices areequipped with a cable in accordance with national regulations.

Make sure that any plug you are using is properly wired:

**For the electrical connection of the device, the legal
Regulations of the respective country!**

Attention

Incorrect voltage can cause the
Damage induction device

Attention

The electrical connections must be carried
out by a specialist.

Commissioning

Assembly

The inductiongeräte are equipped with a power cable. They must be connected to a wall socket or junction box. The electrical installations must be carried out by approved installers in compliance with specific national and local regulations. The installers are responsible for the correct design and installation in accordance with the safety regulations. The warning and type plates must be strictly followed.

Check and make sure that the voltage of the mains current and the device (type plate) match.

When installing this appliance in the immediate vicinity of a wall, partition walls, kitchen furniture, decorative cladding, etc., it is recommended that these are not made of combustible material; otherwise, they must be clad in suitable non-combustible, thermally insulating material, and the fire protection regulations must be observed with the most care!

The inductiongerät must be in a clean, straight surface (table, combination, etc.) ebuilt up and stand by its final destination. It must be installed in such a way that it cannot be moved. The **"installation requirements"** must be met.

Remove all items from the heating zone. Check that the heating zone is neither split nor broken. If you stop commissioning immediately, if the heating zone is split or broken, turn off the deviceimmediately.

Turn the power knob to the OFF position(0) before
Connect inductiongerät to the power grid.

Devices on and off switch

Position OFF: Position ON:



'0' points to the mark () 'I' points to the mark (). oo



Power control with potentiometer

With the potentiometer, the power is infinitely adjustable.

The knob can be rotated via the 0 position. This means that a quick changeover from the low to the high power level and vice versa.

Elements	Description	Function
	Rotary switch 0 position	From
	Rotary switch Range α40°-320°	Power level 1-9



Power control with touch

Instead of the pot (Poti must NOT be connected) the touch display takes over control.

The device is switched on by means of the on-off button.



Performance is set in whole increments from level 1 to 9.

(When the warming function is activated, the power control is done in half steps)



Elements	Description	Function
	On-Off button	Button for 1 sec to press Switching on or off
	On button	increment in 1 steps
	Ab button	decrement in 1 steps

Power control with Spin Control

The set temperature is set on the knob. The direction of rotation has no influence to the function, since in the induction cooktop without a warming function only the performance control is supported.

Elements	Description	Function
	Rotary switch 0 position	From
	Rotary switch Range α40°-320°	Power level 1-9

The power level is displayed on the 3-digit display in the middle.
For this purpose, the LED ring with a strongly luminous LED displays the power position parallel to the rotary knob. When it is moved, a tail appears as an optical effect.







Elements	Description	Function
	Arrow Right	indicates the function-dependent direction of rotation
	Arrow Left	indicates the function-dependent direction of rotation
	Performance icon	lights up with power control, flashes in power mode when pot detection

Warming function (optional)

How do I use the warm-up function



When using this function by means of gags (W70-W110) or activating by the touch control panel, the warming function is active. Attention must **be made** to ensure that the pot dishes must always be placed in the middle of the cooking area (temperature sensor coil).

The warming function is released as an option for the induction cooktop individually per channel. (see controls). Thus, the hob also has a temperature control in addition to the power control. The use of the two functions is subject to the different operating concepts. For grill and hot holder applications, the warming function has no meaning.

Display	Example	Importance	Declaration
Setpoint		Setpoint 90°C Temperature too low	Setpoint is represented by point. Point on the right indicates heating status
		Setpoint 90°C Temperature +/- 4°C	
		Setpoint 90°C Temperature too high	
Actual		Actual value 125°C Temperature too low	Actual value appears every 10 sec for 2 sec.
		Actual value 105°C Temperature too low	
Residual heat		Warning "Hot" Residual heat indicator	Induction switched off and actual value > 45°C, every 10 sec for 2 sec.



Pyro-Sensor ITC

The Pyro-Sensor (ITC) has a center lighting, which lights through the ceramic glass:

Display	Importance	Declaration
	Pot detection	Flashes when induction is turned on and no pot is present
	Residual heat indicator	Lights up when induction is switched off and actual value > 45°C



Warming function with potentiometer

Instead of power levels 1 to 3, the warming temperature can be set from 70-110°C. This is followed by the performance settings from level 4 to 9.

Elements	Description	Function
	Rotary switch 0 position	From
	Rotary switch Range α40-120°	Temperature control 70-110°C (level 1-3)
	Rotary switch Range α120-320°	Power control level 4-9

Warming function with pyro-sensor ITC and electronic potentiometer

When the warming function is switched on, the start-turning direction can be used to be elected. After at min. 1 second off state, the direction of rotation is detected. Thus, in operation, the rotary switch can also be rotated via the 0-position, without change the operating mode.

Elements	Description	Function
	Rotary switch 0 position	From
	Rotary switch Start in Clockwise Range α40°-320°	Power control level 1-9
	Rotary switch start counterclockwise Range α40°-320°	Temperature control 70-240°C

Compatibility mode:





When the electronic potentiometer is set to compatibility mode, it behaves the same as a conventional potentiometer on the standard IO (Warm hold function instead of power level 1 to 3)

Warming function with pyro sensor and touch

Instead of the potentiometer (Poti must NOT be connected), the touch display takes control. The device is switched on by means of the on-off button.

The function key can be used to switch between power control and temperature control. The temperature range is from 70-240°C in 1°C increments with the





Up and down buttons adjustable. The power setting is carried out in half steps of stage 1 to 9. The last used temperature is stored. It also stores whether power control or keeping warm was active.

Elements	Description	Function
	On-Off button	Button for 1 sec to press Switching on or off
	Function button	0.5 sec. Switching between power control and temperature control
	On button	Power setting: Quick press: increment in 0.5 steps Temperature: Quick press: increment in 1 steps Long press: increment in 5 steps
	Ab button	Power setting: Short press: decrement in 0.5 steps Temperature: Quick press: decrement in 1 steps Long actuating: decrement in 5 steps

The set temperature is displayed on the 3-digit display.

The LED ring is also connected to the set temperature range with abrightly Displayed.

The actual temperature is displayed as a weak luminous tail above or below the Target temperature LED. When the target temperature is reached, no tail is visible.







Elements	Description	Function
	Arrow Right	indicates the function-dependent direction of rotation
	Arrow Left	indicates the function-dependent direction of rotation
	Performance icon	lights up with power control, flashes in power mode when pot detection
	Temperature icon	illuminates with temperature control, flashes in temperature mode when pot detection

Warm holder

In contrast to the warming function, which can be switched as an option for power induction, the hot holder is a separate application. (see applications)

The hot holder is a pure temperature control unit. There are 2 temperature ranges to choose from: 60-90°C, 60-150°C



The temperature is measured by means of PT1000 sensors under the ceramic glass.

Display	Example	Importance	Declaration
Setpoint		Setpoint 90°C Temperature too low	Setpoint is represented by point. Point on the right indicates heating status
		Setpoint 90°C Temperature +/- 4°C	
		Setpoint 90°C Temperature too high	
Actual		Actual value 125°C Temperature too low	Actual value appears every 10 sec for 2 sec.
		Actual value 105°C Temperature too low	
Residual heat		Warning "Hot" Residual heat indicator	Induction switched off and actual value > 45°C, every 10 sec for 2 sec.

Warm holder with potentiometer

With the potentiometer, the set temperature can be set

The knob can be rotated via the 0 position. This means that a quick changeover from a low to a high setting value and vice versa.

Elements	Description	Function
	Rotary switch 0 position	From
	Rotary switch Range α40°-320°	Temperature



Warm holder with touch

Instead of the potentiometer (Poti must NOT be connected), the touch display takes control.

The device is switched on by means of the on-off button.



The temperature range is from 70-250°C in 2°C increments with the ups and downs Adjustable. The temperature is stored.

Elements	Description	Function
----------	-------------	----------

	On-Off button	Button for 1 sec to press Switching on or off
	On button	Setpoint setting Quick press: increment in 2 steps Long actuating: increment in 10 steps
	From Taste	Setpoint setting Quick press: decrement in 2 steps Long actuating: decrement in 10 steps

Hot holder with Spin Control



The set temperature is set on the knob. The direction of rotation has no influence function, as only the temperature control is supported with the hot holder.

Elements	Description	Function
	Rotary switch 0 position	From
	Rotary switch Range $\alpha 40^{\circ}$ - 320°	Temperature

The set temperature is displayed on the 3-digit display.

The LED ring is also connected to the set temperature range with abrightly Displayed.

The actual temperature is shown as a weak luminous tail above or below the set temperature LED. When the target temperature is reached, no tail is visible.

Elements	Description	Function
	Arrow Right	indicates the function-dependent direction of rotation
	Arrow Left	indicates the function-dependent direction of rotation
	Temperature icon	illuminates with temperature control, flashes in temperature mode when pot detection

Wipe Control



Control panel for function-dependent operation with 2 touch buttons, touch slider and different display elements.

Inputs for connecting 4 additional PT1000 sensors.

A maximum of two Wipe Control can be used per induction.

Elements	Description	Function
	3 Digit 7 Segment Display	Setpoint display
	LED bar with 19 red LED's	Should / Actual value display
	Backlight	lights bright when the device is in operation
	Companies and products Logo	lights up when the device is in operation
	Touch on/off button	LED indicates that touch button has been detected
	Touch function button	LED indicates that touch button has been detected
	Temperature icon	illuminates with temperature control, flashes at pot detection
	Performance icon	lights up with power control, flashes at pot detection
	Timer icon	Lights up when timer setting flashes when the timer is running
	Lock icon	Lights up when the buttons are locked
	Zone selection display	Displays selected zones Display configurable for läng or cross-mounting

Operation

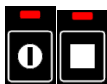

On/offbutton function button

Poweron: 1sec on/off button, turn off: 200msec on/off button

Function key 200msec for zone selection (for dual operation).

Press the function key many times until the desired zone symbol lights up:

1. Zone 1
2. Zone 2
3. Zone 1&2 (Immediately without waiting time after step 2)

Function button 500msec switches between power control and temperature control or timer.

In dual operation, no switching of power control and temperature control can be

be carried out.
Instead, the timer is set for the associated hob.



The middle display shows the power position in parallel with a strongly luminous LED to the Touchslider. When it is moved, a tail appears as an optical effect.
Resolution in half steps 1.0..9.0 = 17 positions,
(new: Boost function is triggered with stay at the highest slider level for 1sec when Boost is enabled,
then the last two bar LEDs are lit)
When the controller is stopped, the PT1000 temperature is optionally displayed with a low-luminous LED on the LED bar of 20-200°C.
The function is displayed with the right triangle.

With pot detection, the power icon flashes synchronously to the search pulse and the backlight lights up dimmed.

Temperature



Should temperature is done with the help of the touch slider as follows:
After switching on, the previously set temperature is displayed in the display, the middle bar LED lights up.

Should temperature adjustment:

1. Preselection: Tap and hold on slider for approx. 0.5sec represents temperature setting range (e.g. 70..240°C) proportionally. Slider center here corresponds to 155°C whereby to the next 10 degrees is rounded up or down. For a smaller range of e.B. 60..150°C, the area code is made in 5°C increments, here the slider center would be 105°C.
2. Adjust fine: Swipe with start in the inner area of the slider from left to right to increase temperature in 1°C steps, respectively from right to left to set temperature lower. It can also be tapped in the inner area to the right and left of the center to adjust the temperature by 1 degree.
3. Adjustment coarse: Swipe with start in the outer area of the slider from left to right to increase temperature in 5°C steps, respectively from right to left to set temperature lower. It can also be tapped in the middle area to the right and left of the center to adjust the temperature by 5 degrees, respectively tap in the outer (1/4 and 3/4) area to adjust in 10 degree increments.

The set set set temperature is displayed in 3 digits on the display. If energy is needed, the right decimal point is also lit.

The set temperature range is always displayed with the middle bar LEDs strongly luminous. The actual temperature is shown as a weaker luminous tail above or below the set temperature LED. When the target temperature is reached, the tail disappears.

When pot detection, the temperature icon flashes synchronously to the search pulse and the backlight lights up dimmed.

Residual heat indicator

Residual heat warning becomes active when switched off. "hot" appears on the display.
The PT1000 temperature is controlled by a low-luminous LED on the LED ring of 20-200°C.

The logo remains illuminated. The backlight lights up dimmed.

Timer



With long pressing of the button, a timer can be started, which will reduce the induction after the set



time and signals the end with a short beep.

there are two methods for setting the time

- a) Tap: Rough adjustment e.B. in std steps by tapping on right or left end of the touch slider. Medium adjustment e.B. 15min steps when tapping on approx. 3/4 and 1/4, fine adjustment in 1min by typing to approx. 60% and 40%
- b) Wipe: Fast movement for rough adjustment, slow movement for fine adjustment

During power cooking, the progress of the timer can be displayed on the 7-segment display. When Temperature cooking is displayed the remaining time in 10sec rhythm for 2sec.

The time is displaying 9.59 ... 0.01 with flashing decimal point (500msec) to make it different can be used for power or temperature display.



The timer can be switched off or deleted again by pressing the button in the Timer mode.

Display in case of error

The error code appears on the display.

When the knob is in the switched-on position: The LED bar does not display anything The logo is illuminated. The backlight lights up dimmed.

Dual operation (1 controller for both channels)

This mode is only available for warming applications



Pot searches: Flashing the ads?

Hot display: as soon as a channel is hot, "hot" is displayed when no channel is active.

Powerstar function double generator (devices with 400V double generator BIPDS)

There can be 2 cooking points with a maximum power of 1.8/3.5/5.0 kW each or only the front cooker with 3.5/5.0/7.0 kW or the rear cooker with 3.0/5.0/7.0 kW.

The Power Star QunktIon Wird WIE Qolgt AktIvieRt:

Vordere KochStelle Belegt, hintHee AusgeschaAccordingen=
3.5/5.0/7.0 kW

HintHee KochStelle Belegt VordHee AusgeschaAccordingen=

Powerstar function (BI2EG3.5xx; BI4EG7xx)

The 230V double generator automatically optimizes the maximum power of 3.5kW. There can be optionally 2 cooking points with a maximum output of 1.8 kW each or only the front cooking unit with 3.5 kW or the rear cooking unit with 3.0 kW. The other cooker must be switched off. When both cookers are operated, the digital display displays level 7 at full power on both cookers. As soon as only one cookroom is occupied again, the display displays level 9 at full power.

The Power Star QunktIon Wird Wie Qolgt AktIvieRt:

Vordere Kochstelle Belegt, hintHee AusgeschaAccordingen=
3.5 kW

Functional

Attention

The hot pan heats up
transferred to the heating zone.
To avoid injury, do not touch the heating
zone.

Use a pan suitable for induction with a minimum floor diameter of 12 cm.

For the functional test of devices with main switches, they must first be switched on, then proceed as described.

Place the pan in the middle of the heating zone and pour some water into it.

- **With LED:** Turn the power knob to ON (a position between Min and Max). The power indicator lamp LED green flashes (cooking level 10%-30%) or lights (cooking level 30%-100%), the water is heated.
- **With digitaldisplay :** (1-9) Turn the power knob to ON (a position between Min and Max). Display shows the selected power between (1-9).
- **With LED:** Remove the pan from the heating zone, so the power indicator lamp must flash (pan search).
- Put the pan back on the heating zone; the power indicator lamp lights up again and the heating process starts anew.
- Rotate the power knob to the 0 position. The heating process is stopped and the power indicator lamp switches off.
- The luminous power indicator lamp indicates that energy is transferred to the pan.
- **With digitalhe display:** (1-9) Remove the pan from the heating zone, so the display (pan search) must display this icon see error messages.
- Put the pan back on the heating zone; the **digital display** again shows the selected power and the heating process starts anew.
- Rotate the power knob to the 0 position. The heating process is stopped and the display is switched off.
- The number in the display indicates that energy is transferred to the pan.

If the power indicator and or LED or digitale indicator remains switched off or flashes only very briefly, check the following:

- Is the inductiongerät connected to the power grid or main switch in?
- Is the power knob on position ON?
- Do you use an induction-ready pan (test with permanent magnets) with a floor diameter of at least 12 cm?
- Is the pan in the middle of the heating zone (except appliances with suction coils with 5-sensor technology or surface coil)?

To check whether the pan material is suitable, use a permanent magnet, which must remain slightly attached to the bottom of the pan. If not, your pan is unsuitable for induction.

Choose a pan recommended for induction.

If the inductiongerät does not work despite the test, you can see under the item Error detection/Troubleshooting.

Operation

Cooking process

The device is immediately ready for operation. The luminous or flashing power indicator light or digital indicator indicates (1-9) that energy is directed to the pan. The power level is selected by rotating the power knob. The inductive power transmission depends on the position of the potentiometer.

Position MIN >minimum power

Position MAX >maximum power

Due to the following circumstances, the cook must be more attentive than when cooking with conventional cooking systems. If the cooking stage is changed by means of a power knob, the cooking material reacts immediately. Empty pans or pots heat very quickly. Never place pans on the ceramic hob without any contents, first add the fat or liquid to the pan and then start cooking. Adjust the heating power by means of a rotary knob exactly according to the desired cooking method. The pan should always be placed in the middle of the heating zone (except appliances with surface coil or suction coil with 5-sensor technique), otherwise the bottom of the pan is heated unevenly. When heating oil or grease, continuously check the pan to prevent overheating or burning of the oil or grease.

Attention! Cookware may only be placed on the stove with a full extent. Do not place hot pots or pans on the control panel, displays or hobs. Ignoring this notice will damage the pots and equipment. **Effect in ignoring:** Pots are welded together, burning the joint material by heat of the pots and thus destroying the seal, leading to penetration of moisture and grease and can thus lead to the defect of the device. Defect of the displays or control panels.

Comfort

The inductiongerät transmits energy only when a pan is on the heating zone. The position of the power knob has no influence on this. When you remove the pan from the heating zone, the transfer of energy to the pan is stopped immediately. When the pan is returned to the heating zone, the preselected power is transferred back to the pan. Switching off with the rotary knob stops the cooking process. However, the device remains ready for operation (standby), only disconnecting from the main surge (or switching off the main switch if available) makes the device powerless.

Pot detection

The pot detection has the task of switching on the inductive heating when a suitable cookware is installed on the ceramic field, or switched off again if this is removed.

The pot detection is carried out inductively with test pulses every second, after 1 minutes the clock rate is reduced to a 5 seconds.





During operation, the pot detection is carried out by the recorded power.

The sensitivity can be adjusted by means of a DIP switch, so that even small cookware is detected.







If an unsuitable cookware (e.B. aluminum pot) is placed, the error message "F" appears.

External display

Startup

Display	Time	Declaration
	1st second	Testing the segments
	2nd second	Operating mode Pulse
	3rd second	Software version 1st digit
	4th second	Software version 2nd digit
	5th second	Software version 3rd digit

Normal operation

Display	Importance	Declaration
	Residual heat indicator	PT1000 Hob Temperature > 45°C
	Pot detection	induction switched on but no pot is put on. Decimal point lights up with pot detection every second after 1 min every 5 seconds
	Operation	Power display 1-9 and decimal point continuous lights: Performance is surrendered
	Reduction 1	Decimal point flash1s: KK temperature limit
	Reduction 2	Decimal point flash500ms: coil temperature limit
	Reduction 3	Decimal point flashing 200ms: Power limit
	Reduction 4	Decimal point flash100ms: HF peak limit (not optimal pan material)

Pot rating

The pot evaluation determines how well a cookware is suitable for the induction system.

Poor cookware, leads to excessive heating of the electronics and to performance limitation. Poor efficiency and limited power control are further significant disadvantages.

To display the pot rating, the induction must be set to maximum performance.

The evaluation varies depending on the connected peripheral.

Pot rating does not work Smart Power Dual operation.

Pot rating light with 1 display

Set to full power and observe flashing point at the 7-segment display at the bottom right.
reduce power until the point is permanently lit.

The performance level, which is then displayed, corresponds to the pot rating
The larger the number, the better the cookware (values of 1-9).



Pot rating premium with 4erdisplay or touch

A pot symbol appears on the left side of the display, next to it a number from 1 to 9.
The larger the number, the better the cookware.
The display goes off after 10 seconds.



Pot rating premium with Spincontrol

The pan symbol at the bottom right lights up, the pan quality is shown with weaker luminous LEDs from the LED ring. With 100% pot quality, all remaining 31 ring LEDs at 50% the lowest 16, at 10% the first 4.
The display goes off after 10 seconds.

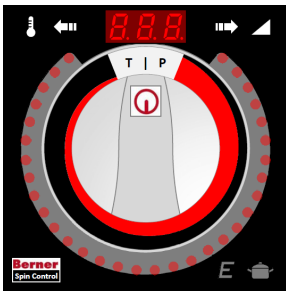

Function with priority circuit (Dual Potentiometer control (optional))











If a second controller is inserted in addition to the standard controller, then the following rule is automatically switched to dual operation (except the master potentiometer function is switched on),whereby the following rule applies:

Only the potentiometer, which comes from the 0 position, specifies the power.



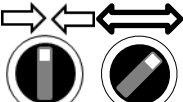









In order to regain the command at a potentiometer that has already been switched on, it must be briefly rotated to the 0 position.

If a potentiometer is finally turned into the 0 position, the cooking area is switched off.
After a power failure, the last set operation continues.

Potentiometer 1	Potentiometer 2	Behavior
-----------------	-----------------	----------

 0 position	 0 position	Device is switched off
 Turn		Device switches on Potentiometer 1 specifies the performance
	 Turn	Potentiometer 2 specifies the performance
 Switching off and on again		Command takeover Potentiometer 1 specifies the performance
	 Off	Device turns off

Master Potentiometer (optional)

Master Potentiometer	Slave Potentiometer 1	Slave Potentiometer 2	Behavior
 0 position	 0 position	 0 position	Device is switched off
	 Turn	 Turn	Induction generators 1 and 2 can be operated independently of each other
 Turn			Both induction generators take over the value of the master potentiometer
 Off			Both induction generators switch off

BIPS (single generator):

The prerequisite for this is a smart power dual operation of both devices, which is achieved by connecting the CAN L and CAN H at the control print of both generators. The **SW1-8** dip switch must also be switched on on both devices on the control press. In addition to the potentiometer, a potentiometer is connected to the generator on only one generator. This now has a master function for both generators. The potentiometers of the individual devices now only work if the master potentiometer is set to NULL position.

BIPDS (double generator):

Switch on the dip switch **SW1-8** on the st.

Master-Potentiometer function for both channels on. If still additional potentiometers are connected to the device, they will only work if the Master-Potentiometer is set to zero position.









Energy

The power limits are set individually for single operation and dual operation per application. Thus, after application, one is reduced the performance in dual operation in order not to exceed the maximum total power. (mostly affects 1x230V inductions)

If energy management is discontinued, the power limits are 1st level (this function is only effective at power level 2)
This also allows for the total load for applications (preferably 3x400V inductions) reduce in dual operation

With the 1x230V induction, the maximum power level in the display is limited to level 7.

Behaviour in dual operation

Potentiometer 1	Potentiometer 2	Reaction
 From	 From	Both channels are made of
 A	 From	Only channel 1 in operation No energy reduction
 A	 A	Both channels in operation Energy reduction active Channel 1 & 2 have reduced maximum power
 From	 A	Only channel 2 in operation No energy reduction

Energy management with Spin Control

If the energy reduction is active, the energy symbol lights up at the lower right of Spin Control.



Decommissioning

If the inductiongerät is not in use, make sure that the main switch or power rotary knob is not turned on unattended. If you do not use the device for a long time (several days), disconnect the device from the main network or turn off the main switch. Make sure that no liquid can get into the grigand do not clean the device with liquid.

Error detection

Warning: During cleaning or maintenance and when parts replace, the equipment must be disconnected from the power supply.

The induction can only be opened by approved and trained service personnel. Stop any work, the Heating zone (ceran glass) can be torn or broken. The inductiongerät must be switched off immediately and From Network Separated Be. Do not touch any parts inside the device.

Attention
when opening the induction device!
Dangerous tension!

Potentiometer Error Handling

If the potentiometer fails during operation or if no potentiometer is detected (and no touch control), the error message "P" appears. This is reset as soon as a potentiometer is detected. If a second potentiometer is connected after starting the device, this is not detected.

In the event of a failure of a potentiometer in the dual-potentiometer control system, it is still possible to continue working with the functional potentiometer. In this case, the error message "P" appears in the switched off state.

In the event of failure of the master potentiometer, further work can be carried out if a slave potentiometer is present. If a slave potentiometer fails, the channel can still be operated with the master potentiometer. The error message "P" appears in these cases when the state is switched off.

Troubleshooting

Error	Possible cause	Measures taken by operators or service personnel
No heating up Power indicator lamp is OFF	No power supply	Check that the device is connected to the power supply (power cable plugged in) or that the main switch is turned on.
	Power knob in OFF position	Turn the power knob into one position
	Main switch is OFF	Turn the main switch into one position
	Pan too small (□ bottom of the pan under 12cm)	Use the appropriate pan.
	Pan is not placed in the middle of the heating zone (pan cannot be recognized)	Slide the pan into the center of the heating zone
	Unsuitable pan	Choose a pan suitable for induction *1
	Inductiongerät defective	Contact your repair service supplier. Unplug the device from the mains.







Insufficient heating capacity Power indicator lamp is ON (lights)	Used pan is not ideal	Choose a pan suitable for induction. Compare the results with 'your' pan.
	Air cooling system is disabled/blocked	Make sure that the air supply and export are not obstructed/blocked.
	Air filter is dirty.	Clean or replace filters.
	Ambient temperature is too high (the cooling system cannot keep the cooker in normal operating temperatures *2	Make sure that no hot air is sucked in. Reduce the ambient temperature. The temperature must not exceed 40°C / 110 °F.
	A phase is missing	Check the backups.
No reaction to turning the power knob	Inductiongerät defective	Contact your repair service supplier. Disconnect the device from the mains.
	Power controller defective	
Heating capacity stops and off within minutes. Fan works	Air cooling system is Blocked/disturbed	Make sure that the air supply and export are not blocked.
	Fan dirty	Cleaning fans
Heating capacity stops and off within minutes. Fan is <u>not working</u> .	Fan or fan monitoring defective	Contact your repair service supplier. Disconnect the device from the mains.
Heating capacity stops and downs within minutes (after longer, continuous operating time)	Coil overheated, Heating zone too hot.	Turn off the device, remove the pan and wait for the heating zone to cool down.
	Empty pan	
	Overheated oil in the pan	
Small metallic objects (e.B. spoon, knife) are heated on the heating zone	Pan detection incorrect Set	Check the control print (only service personnel of supplier!)

*1)To check whether the pan is suitable, use a permanent magnet, which must remain slightly attached to the bottom of the pan. If not, your pan is unsuitable for induction. Choose a pan material suitable for induction.











*2)The ventilation begins to work when the temperature of the cooling plate exceeds 45°C. At cooling plate temperatures above 70°C, monitoring automatically reduces performance to keep the power part under normal operating conditions.
The inductiongerät continues normally with reduced maximum power.

If the mains connection line of this device is damaged, it must be replaced by the manufacturer or its customer service or a similarly qualified person to avoid hazards.

Overview Alerts on Display

Display	Importance	Declaration
	Raw mode	Development and diagnostic mode No limits active! Display only on standby
	DC Overcurrent	DC current greater than 350mA (too many or wrong fans) flashing. Display every 10 seconds for 1 second.
	Fan error	Fan not connected or blocked Display appears every 10 seconds for 1 second. Criterion: Fan level high min. 150mA or RippleStrom >80mA (blocked fan). Note: With temperature controller, only in standby.
	Wrong pot	unsuitable cookware - proportion of paramagnetic material too high (e.B. aluminum). Cooktop is released after 5s.
	HF Overcurrent	defective coil or coil cable (winding or ground closure) Cooktop is released after 10s.
	RTC error	Real Time Clock not ready (warning is only displayed in test mode, no longer active for newer versions)

Overview Faults on display

Display	Importance	Declaration
	Fault 1	Missing or defective Poti, value >1075
	Fault 2	Overtemperature or missing PT1000 value > 260°C
	Fault 3	Short-circuited PT1000 or value < -15°C
	Fault 4	Heat sink temperature > 100°C or NTC short-circuited
	Fault 5	Heat sink temperature < -15°C or NTC interrupted
	Fault 6	Enable signal for output stage is missing
	Fault 7	AC Phase-Zero < 160V
	Fault 8	Disruption RS485 Communication
	Fault 9	Reserve
	Fault 10	Failure of the AC-RMS measuring module display continuous
	Fault 11	Flashing "A" invalid application setting

Cleaning

Warning: During cleaning or maintenance and when parts replace, the equipment must be disconnected from the power supply.

List of detergents for certain types of contamination:

Type of pollution	Cleaner
Light pollution	Moist cloth (Scotch ®) with something Industrial kitchen cleaning products
Fatty spots (sauces, soups,...)	Polychrome, Sigolin chromium, Inox cream, Vif Super-Cleaner Supernettoyant, Sida, Wiener Klak, Pudol System Care
Lime and water stains	Polychrome, Sigolin chromium, Inox cream, Vif Super-Cleaner Supernettoyant
Highly shimmering metallic discoloration	Polychrome, Sigolin Chromium
Mechanical cleaning	Razor blade, non-scratching sponge

Scratching detergents, steel wool or scratching sponges must not be used as they can damage the ceramic surface.

Residues of detergents must be removed from the ceramic field with a damp cloth (Scotch ®) as they can corrode during heating. Professional maintenance of the induction device requires regular cleaning, careful treatment and service.

No liquids must enter the device!

Guarantee

You have purchased a high-quality product with a Bernese cooking appliance. As a manufacturer, we provide a guarantee of one year from the date of purchase.

[Repair during the warranty period](#)

Please contact your specialist wholesaler.

Maintenance

The user must ensure that all components relevant to safety are functional at all times. The inductionSg must be checked at least once a year by a trained technician from your supplier. At least every 6 months, the air filter must be checked for contamination.

Attention

Do not open the induction device!
Dangerous tension!

The induction can only be opened by trained service personnel.

Attention! For technical control, the induction device must be "visibly disconnected" from the power supply.

Disposal

When the life of the induction is terminated, it must be disposed of professionally.

Avoid abuse:

The induction device must not be used by unqualified persons. Avoid recommissioning the device provided for disposal. The device consists of common electrical, electromechanical and electronic components. No batteries are used. The user is responsible for the professional and safe disposal of the device.

Note on disposal

Devices intended for this purpose can be sent to us for disposal. Only prepaid packages are accepted by us.



enough

Delivery:

Berner- Kochsysteme GmbH & Co. KG

Sudetenstrasse 5 - D - 87471 Durach

Tel. +49 (0) 831/697247-0; Fax. - 15

Email: Berner@induktion.de | www.induktion.de

Technical documents

Installation drawings, spare parts lists, user manuals and CE declarations
You can find it at:

www.induktion.de  www.induktion.de/download.html

Generatorviews

Spule

Adapterblech

Platine

Generatorblech2

Generatorblech1

Lüfter

Spule und Generator können getrennt werden

Leistung: elektronisch einstellbar
 1x 3,5 KW 400V
 1x 5,0 KW 400V
 1x 7,0 KW 400V
 1x 8,5 KW 400V

Option: Temperatursteuerung
 Zusatzprint 5 Fühler Funktion

Spule

Winkel

Generatorblech3

Lüfter

Spulen und Generator können getrennt werden

Winkel

Generatorblech1

Platine

Generatorblech2

Leistung: elektronisch einstellbar
 2x 3,5 KW 7KW 400V
 2x 5 KW 10KW 400V

Option: Master Poti Funktion
 Regelung links/rechts oder Komplett zusammen
 Temperatursteuerung
 Warmhaltefunktion

Spule

Generatorblech1

Generatorblech2

Platine

Lüfter

Spule und Generator können auch getrennt werden

Leistung: 1x 3,0KW 400V (2x 400V)
 1x 3,5 KW 400V (2x 400V)
 1x 4,0 KW 400V (2x 400V)
 1x 5,0 KW 400V (2x 400V)

Option: Warmhaltefunktion
 Temperatursteuerung

Spule

Winkel

Spulenträger

Generatorblech1

Generatorblech2

Schacht

Lüfter

Spule und Generator können auch getrennt werden

Winkel

Spulenträger

Platine

Leistung: nur vorne 2,5 KW oder 2x 1,8 KW 3,6 KW 230V
 nur vorne 3,0 KW oder 2x 1,8 KW 3,6 KW 230V
 nur vorne 3,5 KW/ nur hinten 3,0 KW oder 2x 1,8 KW 3,6 KW 230V

Spule

Spulenträger

Erweiterungsblech

Winkel

Generatorblech1

Generatorblech3

Lüfter

Spulen und Generator können getrennt werden

Erweiterungsblech

Winkel

Generatorblech1

Platine

Generatorblech2

Leistung: elektronisch einstellbar
 2x 3,5 KW 7KW 400V
 2x 5 KW 10KW 400V
 2x 3,5 KW 7KW 400V Opti Star Anschlußwert optimiert
 Kochstelle vorne und hinten alleine 5KW
 Beide Kochstellen 2x 3,5 KW
 warmhalte Funktion

Spare parts

BIPS-Generator

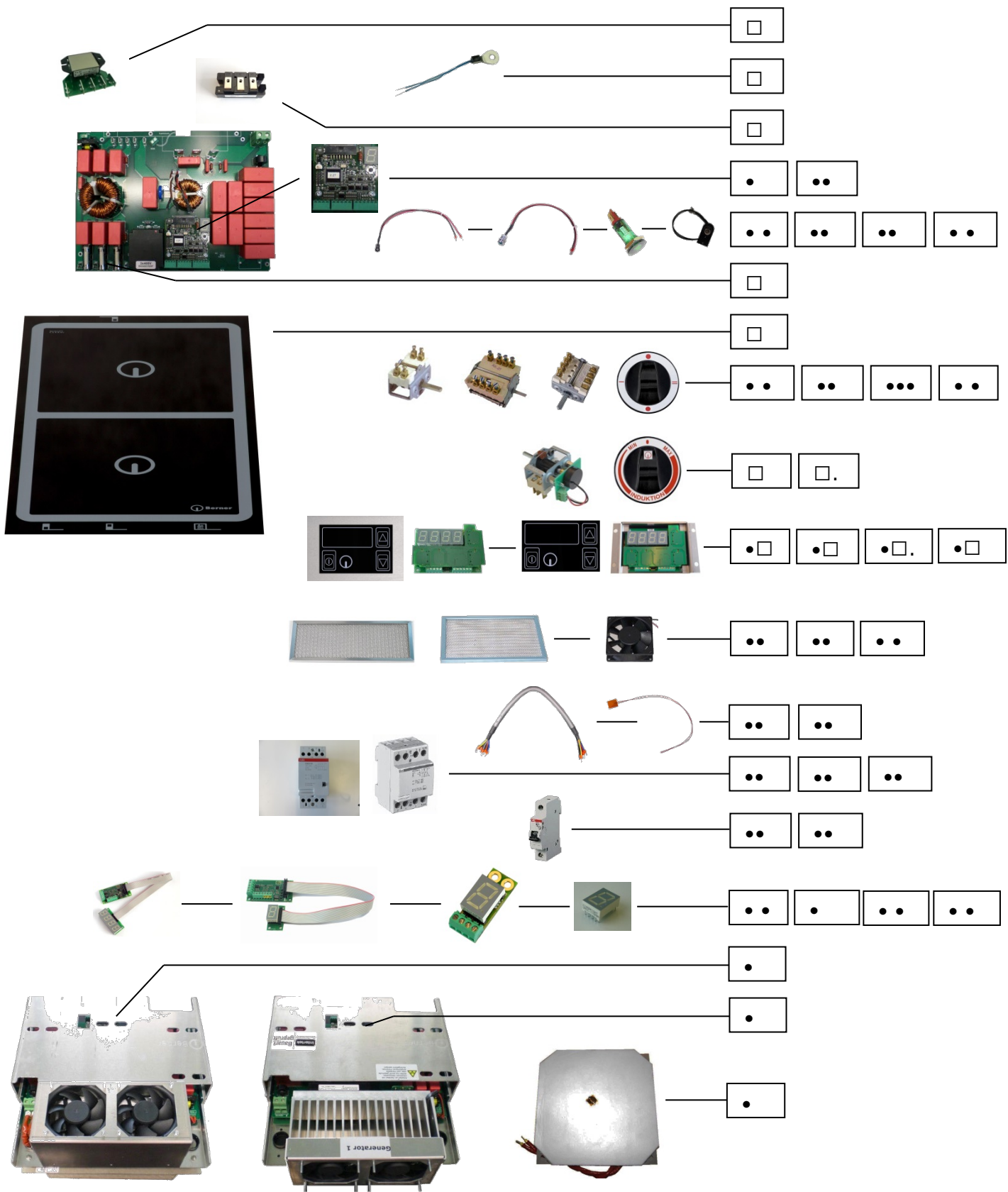

BIPMS Generators

Devices with BIPMS generators:

BI1EGM2.5, BI1EGM3.5, BI1EGS2.5, BI1EGS3.5, BI1EGS5,
 BI1EG2.5B, BI1EG3.5B, BI1EG5B, BI1EG3.5, BI1EGR3.5, BI1EG3.5GN, BI2EG5M, BI2EG7M,
 BI3EGQ10, BI4EG10M, BI4EG14M, BI1EGMO, BI2EGMO, BI3EGMO, BWEB3.5, BWEBFW3.5,
 BWEBM2.5, BWEB BWEBM3.5, BWEB2MQ5, BWEB2MQ7, BWEB2M5, BWEB2M7, BI1EGSW,
 BI1EGW, BI1EGGSW, BI1EGGW, BI1EGS3.5T, BI2EGS7QT, BI2EGS10QT, BI2EGS7TK,
 BI2EGS10TK, BI4EGS14TK, BI4EGS20TK, BWEBT3.5
 BK2EG, BK2EGK, BK4EG, BK4EGK

□□□□□□□□□□□□□□□□					□□□	□□□□□□□ □□□□□□□ □□□□□□□□ □□□□	□□□□□□□□□□□□□□	□□□□□□□□□□□□
□□ □□	□□ □□	□□ □□	□□ □□	□□ □□	□	□□□□□□	□□□□□□□□□□□□□□ □□□□□□□□□□□□ □□□□□	□□□□□□□□□□□□□□ □□□□□□□□ □□□□□

							□□□□□□□□	□□ □□□□□□□□
□	□	□	□	□	□□□ □	□□□□□□	□□□□□□□□□□□□ □□□□	□□□□□□□□□□□□ □□□□
□	□	□	□	□	□□□ □	□□□□□□	□□□□□□□□□□□□ □□□□□□□□□□	□□□□□□□□□□□□ □□□□
□	□	□	□	□	□□□ □	□□□□□□	□□□□□□□□□□□□ □□□□□□□□□□	□□□□□□□□□□□□ □□□□
□	□	□	□	□	□□□ □	□□□□□□	□□□□□□□□□□□□ □□□□□□□□□□	□□□□□□□□□□□□ □□□□
□	□	□	□	□	□□	□□□□□□	□□□□□□□□□□□□ □□	□□□□□□□□□□□□ □

BIPDS Generator

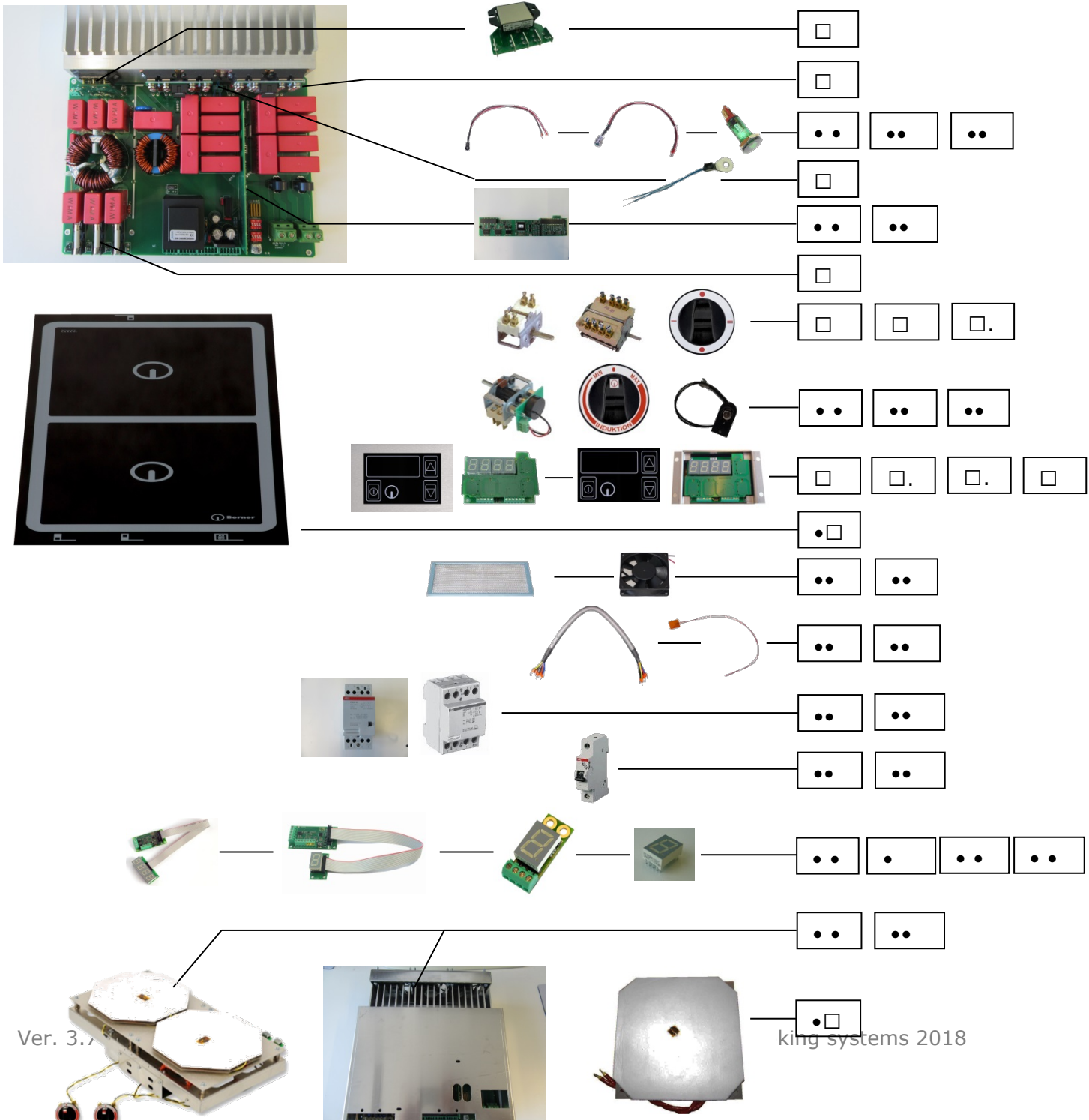

BIPDSGenerators

Devices with BIPDS generators:

BI1EGSP2, BI1EGSM2, BI1EGSPW2, BI1EGSPQ2, BI1EGSPL2, BI2EGQ7, BI2EGQ10, BI2EGFFQ7, BI2EG7, BI2EG10, BI2EGFF7, BI2EG7K, BI2EG10K, BI2EGF7K, BI2EG7SK, BI2EG10SK, BI4EG14, BI4EG20, BI4EGD14, BI4EGD20, BI4EGDF14, BI4EG14K, BI4EG20K, BI4EGD14K, BI4EGD20K, BI4EGDF14K, BI4EG14SK, BI4EG20SK, BI6EG21K, BI6EG30K, BI6EG30K, BI6EGAF21K, BI2EGAQ7, BI2EGAQ10, BI2EGA7, BI2EGA10, BI2EGAR10, BI4EGA14, BI4EGA20, BI6EGA21, BI6EGA30, BI4EGAL14, BI4EGAL20, BI2EGLQ10, BI2EGL10, BWEB2Q10

□□□□□□□□□□□□□□ □□				□□□ □	□□□□□□□□ □□□□□□□□ □□□□	□□□□□□□□□□□□□□	□□□□□□□□□□□□□□
□□	□□	□□	□□	□□□	□□□□□□□□	□□□□□□□□□□□□□□	□□□□□□□□□□□□□□
□	□	□	□	□	□□□□□□	□□□□□□□□□□□□□□	□□□□□□□□□□
□	□	□	□	□	□□□□□□	□□□□□□□□□□□□□□□□ □□□□□□	□□□□□□□□□□□□□□□□ □□□□□□
□	□	□	□	□□□	□□□□□□	□□□□□□□□□□□□□□□□ □□□	□□□□□□□□□□□□□□□□ □□
□	□	□	□	□□□	□□□□□□	□□□□□□□□□□□□□□□□ □□□	□□□□□□□□□□□□□□□□ □□□
□	□	□	□	□□□	□□□□□□	□□□□□□□□□□□□□□□□	□□□□□□□□□□□□□□□□ □□□□
□	□	□	□	□	□□□□□□	□□□□□□□□□□□□□□□□	□□□□□□□□□□□□□□□□ □
□	□	□	□	□□□	□□□□□□	□□□□□□□□□□□□□□□□ □□□	□□□□□□□□□□□□□□□□
□	□	□	□	□□□	□□□□□□	□□□□□□□□□□□□□□□□ □□□□□□□□□□□□□□□□	□□□□□□□□□□□□□□□□ □□□□□□□□□□□□□□□□
□	□	□□	□□	□	□□□□□□	□□□□□□□□□□□□□□□□ □□	□□□□□□□□□□□□□□□□
□	□	□	□	□□□	□□□□□□	□□□□□□□□□□□□□□□□ □□□□	□□□□□□□□□□□□□□□□
□	□	□	□	□□□	□□□□□□	□□□□□□□□□□□□□□□□ □□□	□□□□□□□□□□□□□□□□
□	□	□	□	□□□	□□□□□□□□ □	□□□□□□□□□□□□□□□□ □□□	□□□□□□□□□□□□□□□□ □□
□	□	□	□	□□□	□□□□□□□□ □	□□□□□□	□□□□□□
□	□	□	□	□□□	□□□□□□	□□□□□□□□□□□□□□□□	□□□□□□□□□□□□□□□□

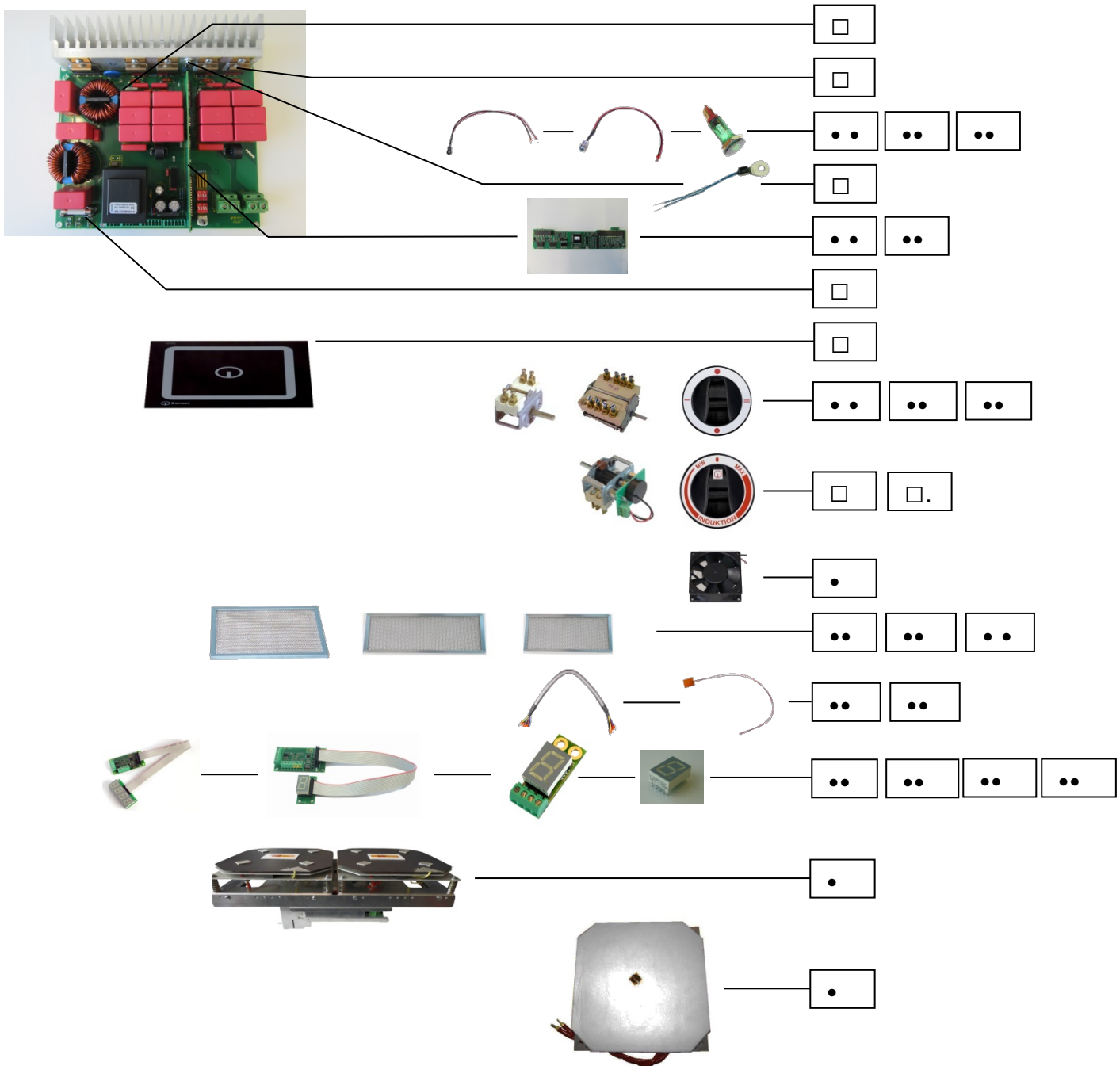

□	□	□□	□ □□□	□□□□□□□□□□□□□□□□ □□	□□□□□□□□□□□□□□□□ □□
□	□	□□	□□-□-□	□□□□□□□□□□□□□□□□ □□	□□□□□□□□□□□□□□□□ □□
□	□	□□	□□□□□□	□□□□□□□□□□□□□□□□ □□□□□□□□	□□□□□□□□□□□□□□□□ □□□□□□□□

Technical documentation

Gluing scheme for flush-mounted installation

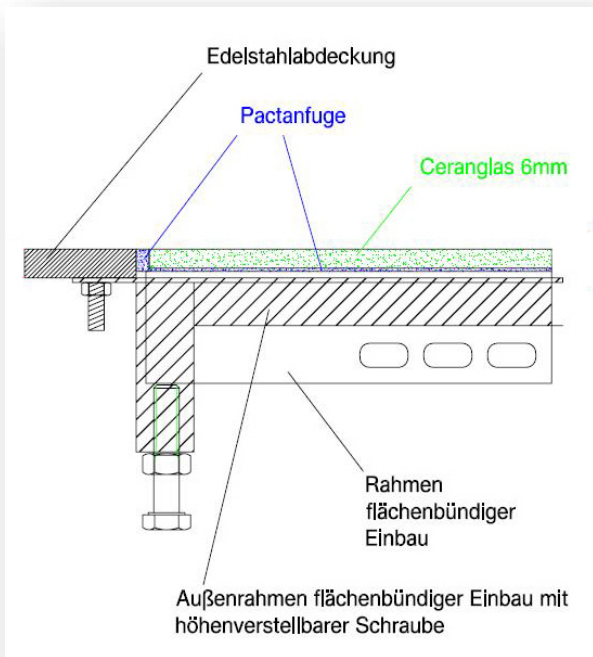

Air flow

Air flow module

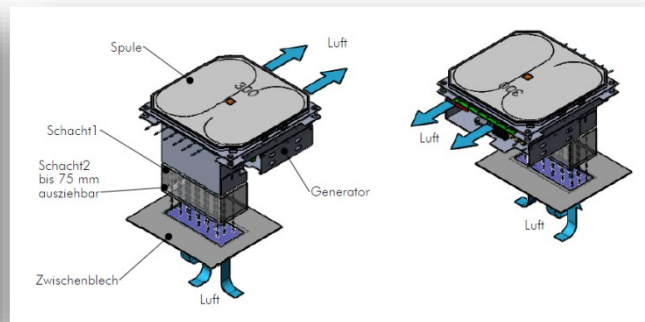
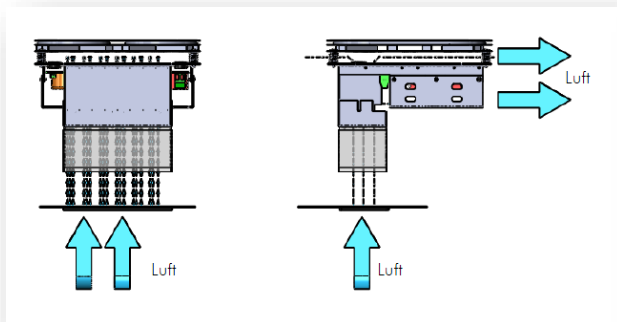

Air way coil generator Separate (Standing/ Lying)

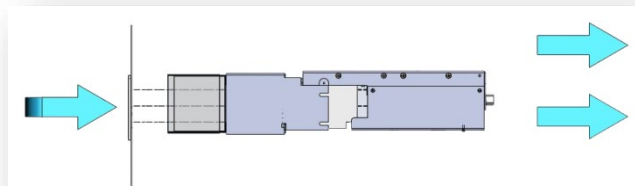
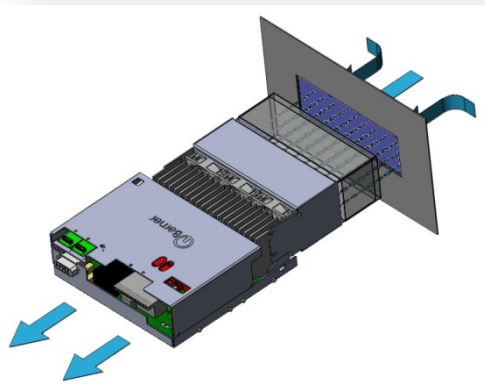

Observe installation regulations

Supply air guide via guided channels from below (option from front or rear)
(Option with Flex. supply air hose).

Under the induction, a floor plate must be attached, on which supplied CNS angle (as guide for the aluminium air filter). It is essential that the floor plate is removable so that, in the event of service, access to the generator, or in the case of a separate variant, access to the coil, is guaranteed for the service technician. If this is not possible due to the design, other installation variants must be checked. We are ready to provide support in this regard.

The use of the grease filters means that less dirt and grease penetrates into the device. The Alu grease filter must be accessible and easy to remove. (weekly cleaning in the dishwasher).

The air outlet is carried forward via the switch panel. For this, openings in the switch panel are required. Optionally, the air outlet can also be discharged via an exhaust air chimney. For this, the generators may need to be rotated.

The exhaust air chimney must be installed in such a way that no spray or dirty water can reach the generators from below or above.

The switch panel is not included, this is available as an option.

Please note! For appliances in combination with **ovens**, the switches-blinds must be closed (no ventilation slots must be present) to prevent the penetration of moisture and heat over them.

In order to ensure proper functioning, it is essential to observe the supply and exhaust air flow.

The mounting frame of the built-in device must be sealed downwards (Silicon-Pactan 6076) to prevent the penetration of liquids.

In case of broken glass or damage to the ceramic hob, please DO NOT continue to use and renew ceranglass immediately, otherwise there is a risk of liquid penetrating.
This results in damage.

Installationsvorschriften

The following points must be observed:

- Check and make sure that the voltage of the main supply line matches that of the type plate.
- The electrical installations must comply with local building installation regulations. The applicable national regulations of the electricity authorities must be complied with.
- The inductiongerät is equipped with a power cable, which can be connected to a socket with the necessary plug.
- If incorrect current circuit breakers are used, they must be designed for a fault current of at least 30mA.
- Prevent blocking of the air supply and air outlet zone by objects (fabric, wall, etc.)
- Avoid that hot ambient air is sucked in by the inductiongerät (several devices stand side by side, devices stand one after the other, near frying tippers or ovens). Otherwise, a duct must be used.
- The inductiongerät must not be placed near one or on a hot surface.
- The device has a suction filter. Nevertheless, you must ensure that no fat ambient air caused by other applications can be sucked into the inductiongerät (near fritteusen, grill plates or frying tippers).
- The air intake temperature must be below +35°C.
- Operators must ensure that all installation, maintenance and inspection work is carried out by approved personnel.
- If other built-in devices are installed near the induction or are located nearby, which are electronically controlled, please ask the manufacturer if interference caused by the induction is possible.

Additional installation requirements for the installation model

- The intake air must be channelled and fed directly to the fans via the supplied filter. The suction cross-section should be at least 200 cm².
- The maximum intake air must never exceed the temperature of 35°C directly in front of the fans.
- Do not build a thermal short circuit. The exhaust air must not be sucked back in, otherwise the device will become hotter and hotter.
- The installation must be checked for practicality. For this purpose, the maximum cooling plate temperature must be determined. The measured plate under the induction coil in the middle of the transistor module (black large block) is measured at the cooling plate base plate below the induction coil. The temperature must not exceed 50°C in continuous operation of at least 2 hours and 20°C ambient temperature.
- Shield the potentiometer line at lengths above 60 cm and connect it to terminal S only on the induction module.
- The generator supply must be generally shielded and contacted cleanly on both sides.
- Provide the mains disconnecter in such a way that a maximum of 5 times per day is switched on and off.

Attention points for remote coil (coil - generator separated)

- With shock connector and 6 mm² Radox strand (155°C) extend the coil connections and solder with.
- Extend sensor cable with 2 x 0.5 mm² oil flex cable.
- Sensor and display cables must be laid separately from coil cables and all other cables and, if possible, placed in a steel channel, as the interference emission is very high.
- The cooling system is designed in such a way that the coil is also cooled (see air guide). This is no longer the case with a detached coil. The coil should therefore be ventilated separately (optionally available), so that the temperature of the ferrite rods does not exceed 140°C in continuous operation (check by means of temperature measurements).
- No sheets may be mounted under the coil which are less than 6 cm apart, except for aluminium, where 2.5 cm is considered the minimum distance.
- The module complies with EMC standards and electrical safety requirements. If the coil is removed, some tests must still be repeated. e.B. temperature tests, EMC test, electrical safety. The execution of the inspections is the responsibility of the user and should be confirmed by an accredited inspection body.

Installation instructions for the installation of Induction devices with support frame (Ver. A)

Please note the following installation instructions. This is the only way to ensure trouble-free operation and a long service life. In the event of a breach of these requirements, the device warranty expires.

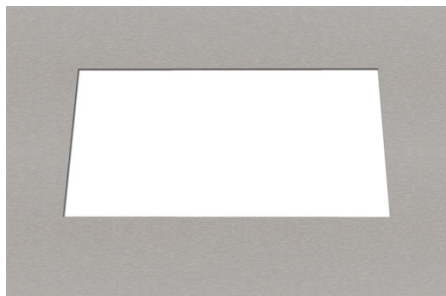

Make the cut-out in the work surface according to the installation drawing. (Please only use current drawings). Use only suitable materials (stainless steel at least 3mm or granite).



Close to the edge of a circulating Pactanfuge. Apply continuously without interruption to prevent a later penetration of moisture downwards.



Insert the unit into the cut-out and firmly move the unit to the work surface.

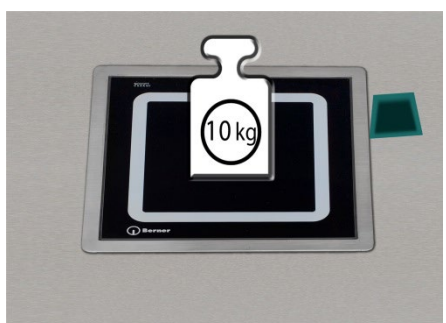

Weighing the unit and pulling off Pactan Resten protruding from the groove with a suitable pull-off rubber.

Important: Observe drying time of at least 24h. Closed joints harden much more slowly than open joints.

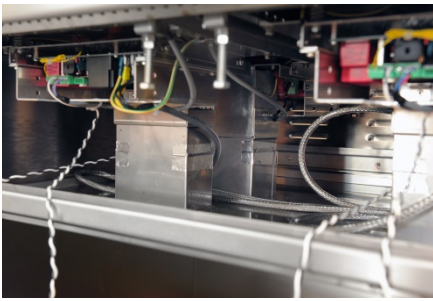

Laying of the connecting cables.

Please note in case of separate generator installation:

Sensor, display and probetapped cables (control cables) must be laid separately from coil cables and generator cables and, if possible, placed in a steel channel.

Coil cables must not be routed in metal ducts and must not be laid bundled.

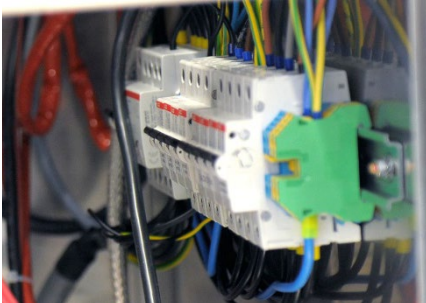

Attach and wire the hat rail with the automatic safety machines. Please place these vending machines splash-proof and safe to access. However, they must remain accessible in order to be switched back on by the device operator in the event of a triggering. They provide an additional backup of the system.

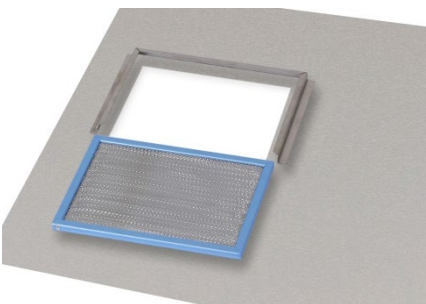

Grease filter with mounting frame for attachment to the revision floor.

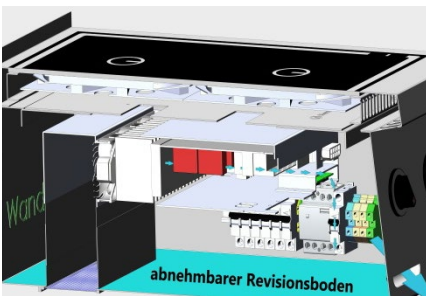

Insert an intermediate floor (removable for repair case) with the cut-outs for the grease filters (cut-out positions see installation drawings) and connecting the air shaft tubes with the intermediate floor and bonding of the bumper edges with aluminium adhesive tape to avoid sucking in fatty air.



The air sucked in for generator cooling may only be sucked in by the openings covered with grease filters. These grease filters must be cleaned at appropriate intervals, depending on the contamination. The induction devices must not be operated without these filters, otherwise the electronic components will be damaged.

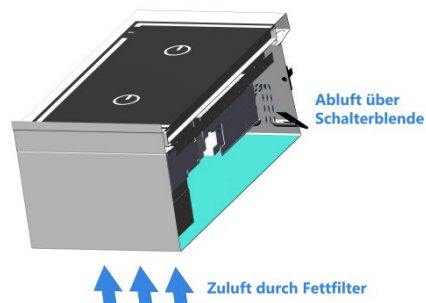

Attach a switch panel equipped with air slots to ensure the exhaust air forward.

Important: The air slots must only be opened downwards to avoid the penetration of liquid. Please use only fog-moist wipes when cleaning the equipment. No splashing water!

Installation instructions for flush-mounted installation (Ver. B) of induction devices

Please note the following installation instructions. This is the only way to ensure trouble-free operation and a long service life. In the event of a breach of these requirements, the device warranty expires.



Making the cut-out in the work surface according to Built-in drawing. **Glass dimension + all-sided 3mm joint**

(Please only use current drawings).

Only suitable materials (stainless steel at least 3mm or granite).

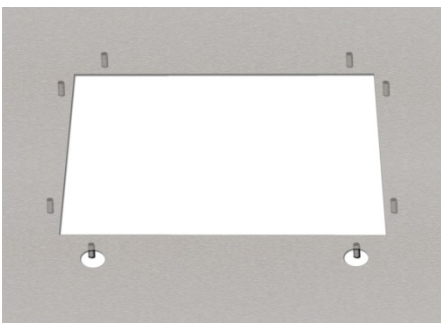

Attach bolt M6 to the bottom of the work surface according to the drilling pattern in the installation drawing or mounting frame.



Screw the mounting frame to the bottom. Important! Observe the tensile strength of the welding bolts and the fixed seat of the screws.

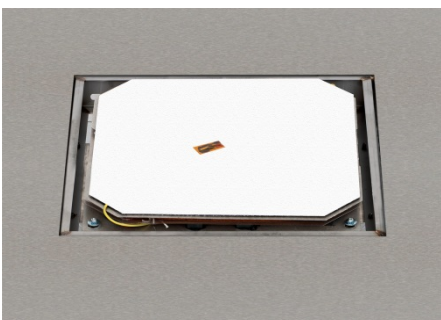

Inserting the induction unit from above and laying the connecting cables. **Please note in case of separate generator installation:** Sensor, display and probetapped cables (control cables) must be laid separately from coil cables and generator cables and, if possible, placed in a steel channel.



Apply a thin Pactanschicht on the inner frame to fix the ceramic glass. Please apply in the area of the display only very sparingly to prevent the ad segment from sticking.



Insert the ceramic glass into the fresh Pactan schicht on the inner frame. Make sure that the display is not covered with Pactan.

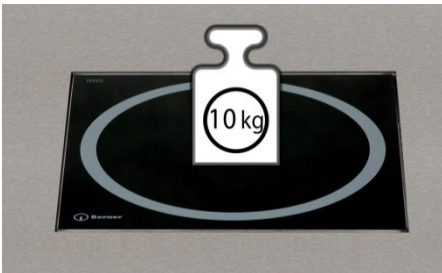

Ceramic glass (all-sided joint width approx. 3 mm). Weigh glass sufficiently.
Important: Spring preload of the coil must be overcome and the ceramic glass firmly on the internal frame.

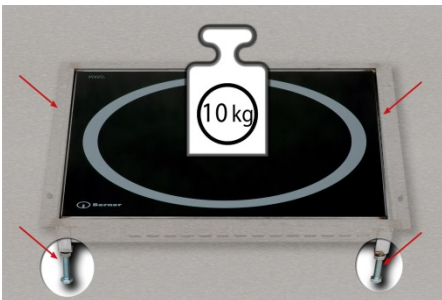

Surface-levelling of the unit with the help of the Adjustablebar srobes on the mounting frame.
Important: Please secure adjustment screws with the Counter nuts M8.

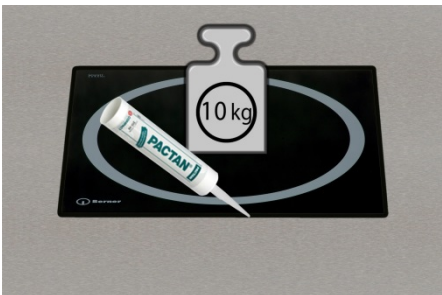

Fill the side joints between ceramic glass and work surface with sufficient pactan. Easily run over material.
Important: Please apply only very sparingly in the area of the display to prevent the ad segment from sticking.

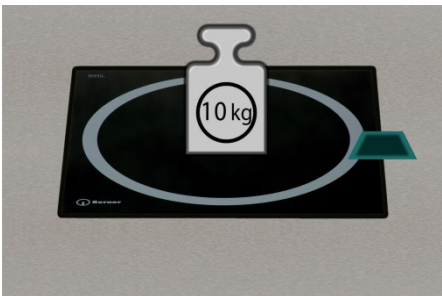

Spray wet Pactan Fuge with wetting agent and drain the excess material with a suitable puller.
Important: Observe drying time 24h per 1 mm joint thickness!

Installation instructions for the installation of Sensor keypads with support frame (Ver. A)

Frame incl. electronics is vorassembled with glued ceramic glass

Please follow the instructions on page 29

Please note the following installation instructions. This is the only way to ensure trouble-free operation and a long service life. In the event of a breach of these requirements, the device warranty expires. [Installation versions](#) [See PL2013](#) on [page 210](#).

Beispiel: Einbau in Schalterblende

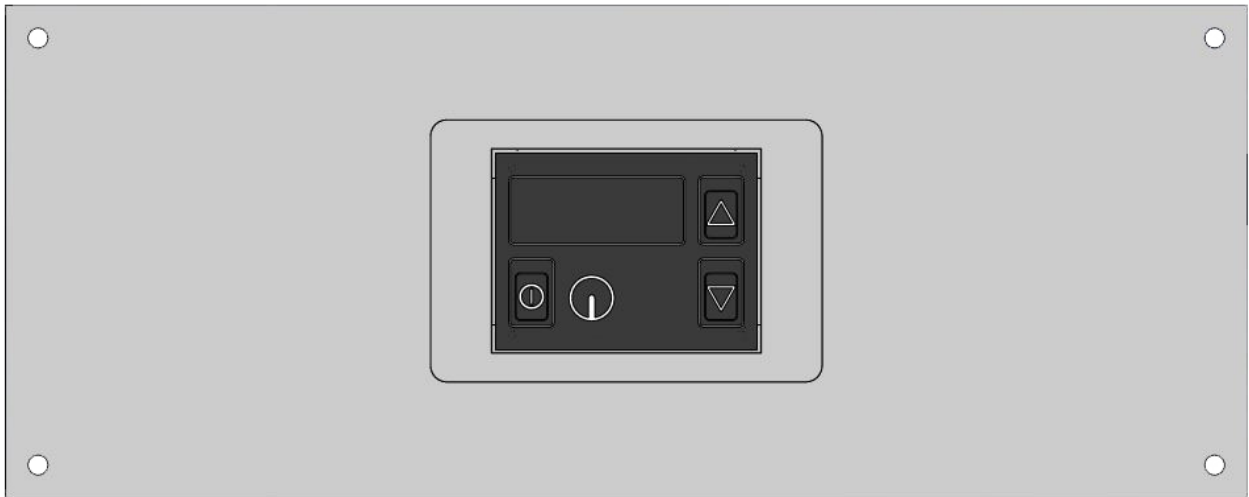

Explosion: Version A montierte Version

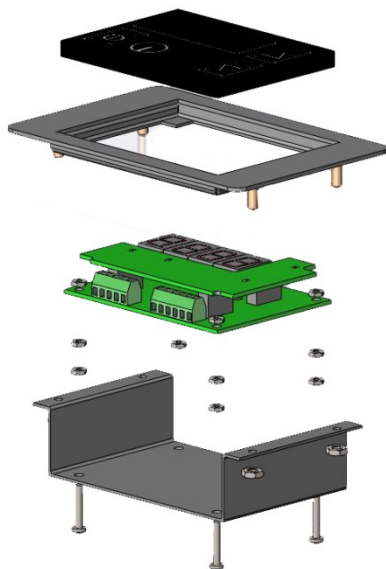

Installation instructions for flush-mounted installation (Ver. A2) of sensor keypads

Frame incl. electronics is pre-assembled with glued ceramic glass

Please follow the instructions on page 29

Please note the following installation instructions. This is the only way to ensure trouble-free operation and a long service life. In the event of a breach of these requirements, the device warranty expires. [Installation versions](#) [See PL2013](#) page 210.

Beispiel: Einbau in Schalterblende

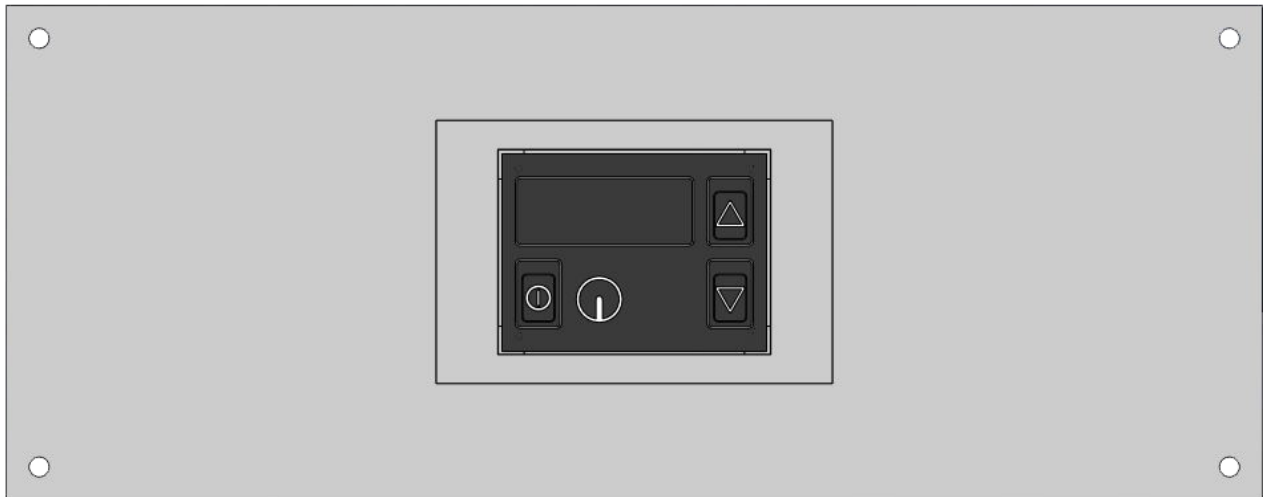

Explosion: Version A2

montierte Version

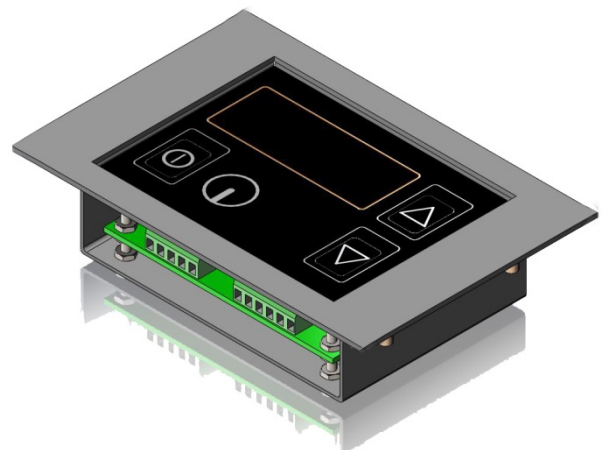
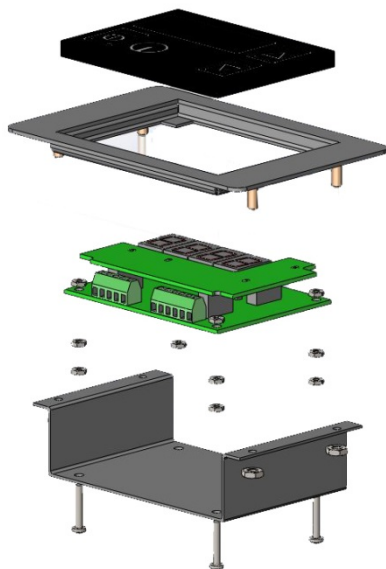

Installation instructions for flush-mounted installation (Ver. B) of sensor keypads

Frame incl. electronics is pre-assembled with glued ceramic glass (2 - 3mm projection)

Please follow the instructions on page 31

Please note the following installation instructions. This is the only way to ensure trouble-free operation and a long service life. In the event of a breach of these requirements, the device warranty expires. **Installation versions** [See PL2013](#) page 210.

Beispiel: Einbau in Schalterblende

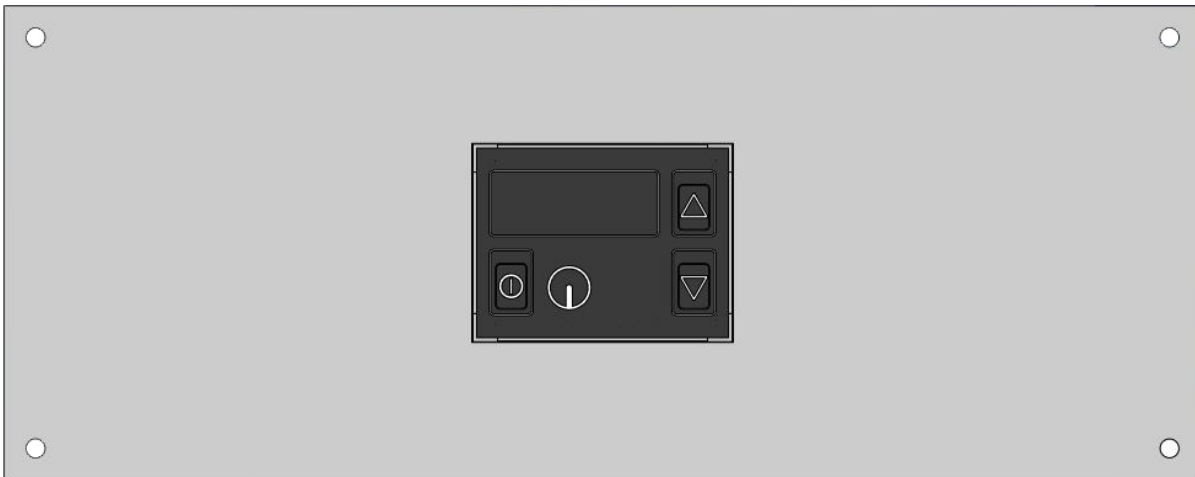

Explosion: Version B

montierte Version

